

Features

- 360 degree emitting offers all direction views
- IP67 rated, ideal for outdoor uses
- 3 years warranty

Applications

Libraries, coffee shops, offices, lobbies, malls, studios, etc.

Date	Fixture type
Project name	Project phase

Bending Directions & Diameters

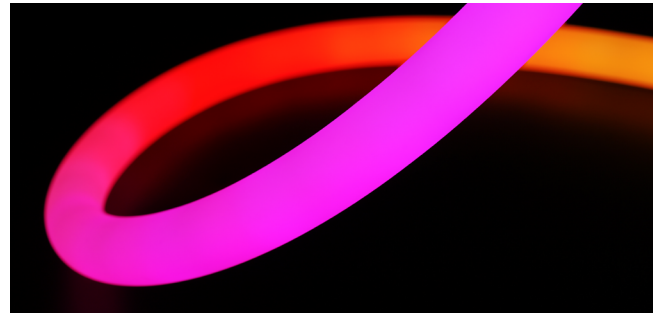
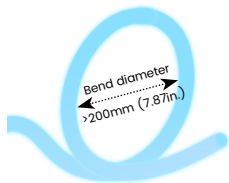

Dimensions

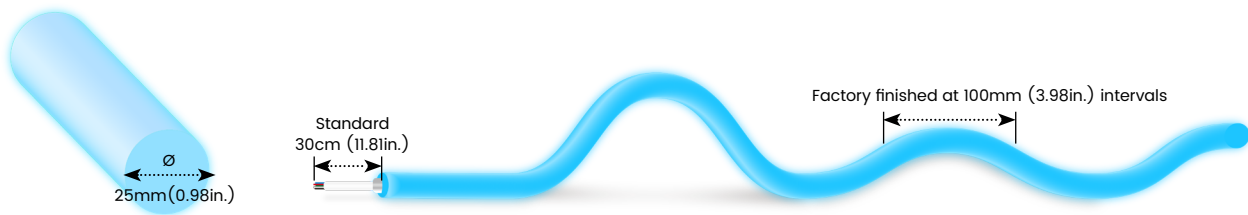

Order Code

Assembly Builder

Model	Bend Direction	Voltage	Control	CCT	Power	Left Feed Entry			
RONDO	3D-3D Bending	24V-DC24V	SPI-SPI control	RGB-RGB	220-22W/M	F	Front	OW	Open wire 30cm(0.98ft)
						S	Side	MC	Male connector with 30cm(0.98ft) cable
						C	Closed	FC	Female connector with 30cm(0.98ft) cable
								NA	Only for Closed Feed Entry

Assembly Builder

Mounting Order Code

Right Feed Entry			Length	
F	Front	OW	Open wire 30cm(0.98ft)	Max. nominal 5m (16.4ft)
S	Side	MC	Male connector with 30cm(0.98ft) cable	Increment 100mm (3.98in.)
C	Closed	FC	Female connector with 30cm(0.98ft) cable	
		NA	Only for Closed Feed Entry	

Product Code

Please select on the Mounting Options page

*We will list the nearest actual manufacturing length on the quotation, based on your requested length.

Lumen Output (lm/m)

CCT	22W/M
R	92
G	320
B	60
RGB	441
Max. Run Length	5m

Technical Details

Efficacy	20lm/W @RGB 22W
Beam Angle	360°
Average Life (L70B10)	>43,000 hours
IC Model	WS2811
Pixels/M	10
Storage Temperature	-40°C~ 60°C
Operating Temperature	-40°C~ 45°C

Photometry

RONDO3D-24-SPI-RGB-220
 RONDO, 3D bending, 24V, SPI RGB, 22W/M

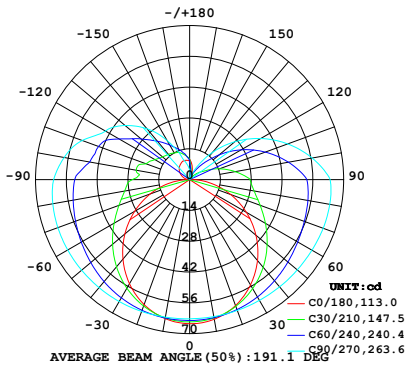

Zonal Lumen Summary

Zone	Lumen	% Fixture
0-30	51.63	11.7%
0-40	87.5	19.8%
0-60	173.4	39.2%
0-90	305.3	69.1%
0-180	441.9	100.0%

Feed Entry / End Cap Options

FT: Flush Translucent – IP67, factory-made only

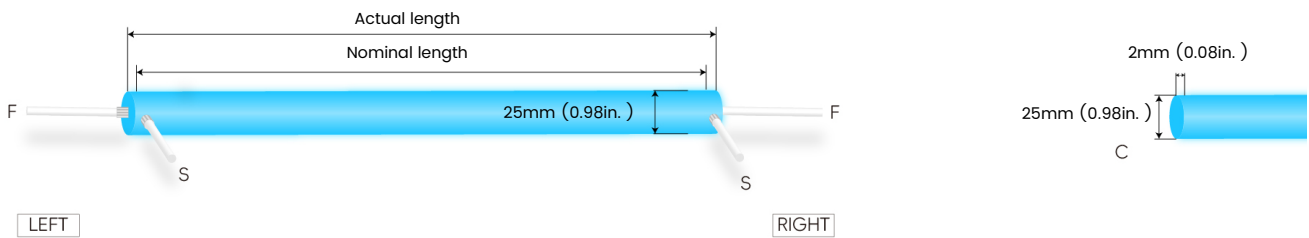

Connector Wire Options



OW: Open wire, **Dry** only
 Standard 30cm (0.98ft), 20 AWG,
 wire length customizable

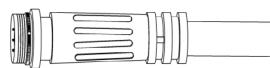

MC: Male connector, **Wet**
 Standard 30cm (0.98ft), 20 AWG



FC: Female connector, **Wet**
 Standard 30cm (0.98ft), 20 AWG

Mounting Options

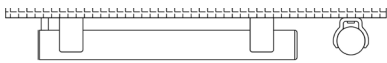

AC201

Name Surface mount clear bracket-open clip

Material PC

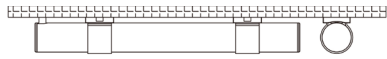

AC213

Name Surface mount clear bracket-closed clip

Material PC

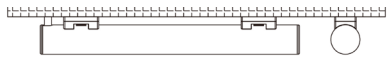

AC215

Name Surface mount clear bracket-low profile clip

Material PC



AC200

Name Surface mount clear bracket-PC channel

Material PC

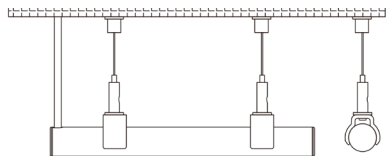

AC204

Name Suspended mount clear bracket-open clip

Material Stainless Steel, PC

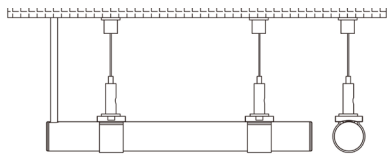

AC214

Name Suspended mount clear bracket-closed clip

Material Stainless Steel, PC

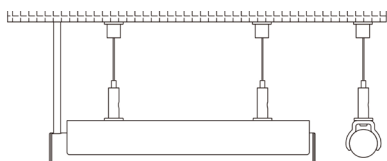

AC211

Name Suspended mount clear bracket-PC channel

Material Stainless Steel, PC

Mounting Options

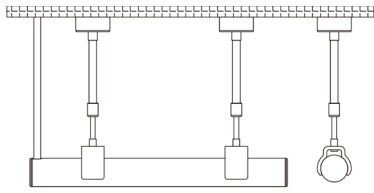

AC217

Name	Telescoping white bracket-open clip
Material	PC
Adjustable Length	500-1000mm(19.69-39.37in.)

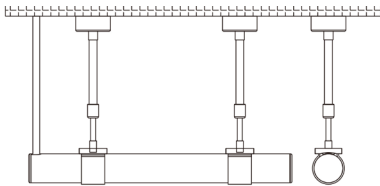

AC219

Name	Telescoping white bracket-closed clip
Material	PC
Adjustable Length	500-1000mm(19.69-39.37in.)

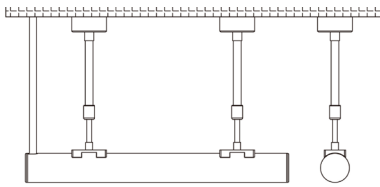

AC220

Name	Telescoping white bracket-low profile clip
Material	PC
Adjustable Length	500-1000mm(19.69-39.37in.)

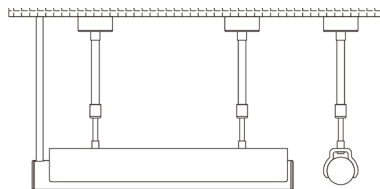

AC218

Name	Telescoping white bracket-PC channel
Material	PC
Adjustable Length	500-1000mm(19.69-39.37in.)

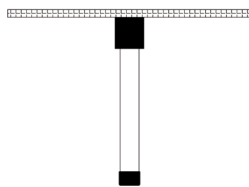

AC206

Name	Vertical metal flush surface mount bracket-black
Material	Aluminum

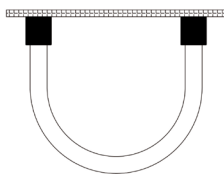

AC208

Name	U-shaped metal flush mount bracket-black
Material	Aluminum

Mounting Options

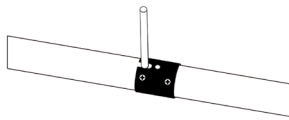

AC209

Name	Metal joiner bracket-black (side cable entry only)
Material	Aluminum

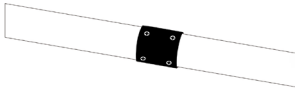

AC210

Name	Metal joiner bracket-black (closed end cap)
Material	Aluminum

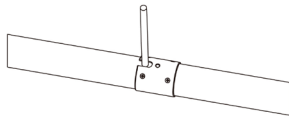

AC209-T

Name	Joiner bracket-clear (side cable entry only)
Material	PC

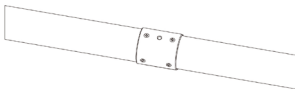

AC210-T

Name	Joiner bracket-clear (closed end cap)
Material	PC

Additional Accessories (Optional, purchase for extra)



MCW-3P-67
Male connector,
30cm (0.98ft) white cable,
3 pin, IP67, Wet, 20 AWG



FCW-3P-67
Female connector,
30cm (0.98ft) white cable,
3 pin, IP67, Wet, 20 AWG



MCB-3P-67
Male connector,
30cm (0.98ft) black cable,
3 pin, IP67, Wet, 20 AWG



FCB-3P-67
Female connector,
30cm (0.98ft) black cable,
3 pin, IP67, Wet, 20 AWG

LEDLINE RONDO SPI RGB

3D Bending · Pixel RGB

Drivers

Non-dimmable

Code	Max Load	Input	Output	Environment	Size (L x W x H)
XLG-150-24-A	150W	100-305VAC	24V	Dry/Damp/IP67	180 * 63 * 35.5 mm
LPV-150-24	150W	180-305VAC	24V	Dry/Damp/IP67	148 * 40 * 30 mm
LRS-150-24	150W	85-132VAC / 170-264VAC	24V	Dry	99 * 97 * 30 mm

SPI-Decoders & Controllers Options

Type	Code	Description	Environment	Size (L x W x H)
Controllers	K-1000C	2048 pixels, SD card playback, ideal for DIY, signage and small venues.	Indoor	159 * 89 * 24 mm
Controllers	T-790K	8-port output, dual-mode control, ideal for facades, stages and large projects.	Indoor	310 * 152 * 42 mm
Controllers	WT-SPI	WiFi & RF 3-in-1 SPI controller for RGB/RGBW lighting	Indoor	114 * 38 * 20 mm

Wiring Diagram

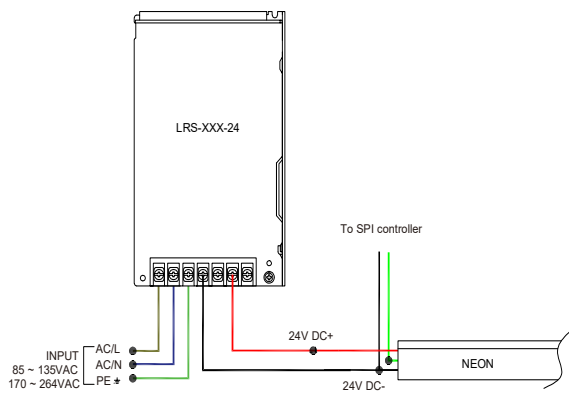
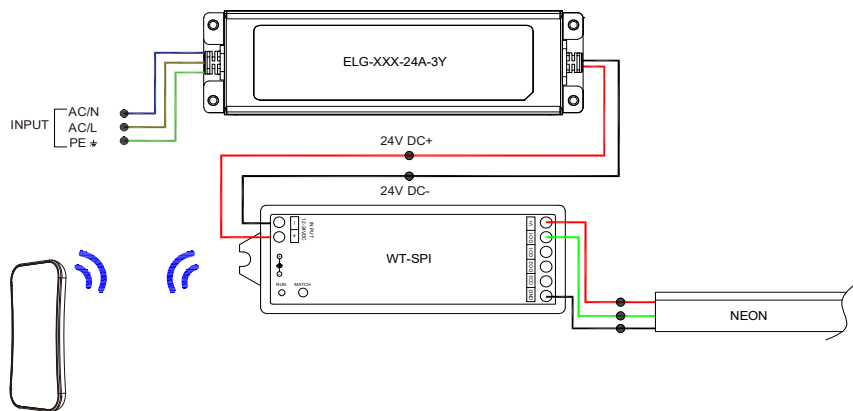

LEDLINE RONDO SPI RGB

3D Bending · Pixel RGB

24V Voltage Drop & Maximum Wire Length Chart

Based on 24V voltage with a 3% voltage drop allowance. Indicates the maximum wire length from the power supply to the start of the run.

Total load	8AWG	10AWG	12AWG	14AWG	16AWG	18AWG	20AWG	22AWG
10W / 0.4A	484.0m	304.5m	191.4m	120.4m	75.5m	47.5m	29.8m	18.5m
20W / 0.8A	242.0m	152.1m	95.7m	60.0m	37.8m	23.7m	14.9m	9.1m
30W / 1.3A	161.2m	101.5m	63.7m	39.9m	24.9m	15.8m	9.7m	6.1m
40W / 1.7A	121.0m	75.9m	47.8m	29.8m	18.9m	11.8m	7.3m	4.5m
50W / 2.1A	96.6m	60.6m	38.1m	24.0m	14.9m	9.4m	5.7m	3.6m
60W / 2.5A	80.4m	50.6m	31.7m	19.8m	12.5m	7.9m	4.8m	3.0m
70W / 2.9A	68.8m	43.2m	27.1m	17.0m	10.6m	6.7m	4.2m	2.4m
80W / 3.3A	60.3m	37.8m	23.7m	14.9m	9.4m	5.7m	3.6m	2.1m
90W / 3.8A	53.6m	33.8m	21.0m	13.1m	8.2m	5.1m	3.0m	1.8m
100W / 4.2A	48.1m	30.1m	18.9m	11.8m	7.3m	4.5m	2.7m	1.8m
110W / 4.6A	43.8m	27.4m	17.3m	10.6m	6.7m	4.2m	2.7m	1.5m
120W / 5.0A	40.2m	25.3m	15.8m	9.7m	6.1m	3.9m	2.4m	1.5m
130W / 5.4A	37.1m	23.1m	14.6m	9.1m	5.7m	3.6m	2.1m	1.2m
140W / 5.8A	34.4m	21.6m	13.4m	8.5m	5.1m	3.3m	2.1m	1.2m
150W / 6.3A	32.0m	20.1m	12.5m	7.9m	4.8m	3.0m	1.8m	1.2m
160W / 6.7A	30.1m	18.9m	11.8m	7.3m	4.5m	2.7m	1.8m	0.9m
170W / 7.1A	28.3m	17.6m	10.9m	7.0m	4.2m	2.7m	1.5m	0.9m
180W / 7.5A	26.8m	16.7m	10.3m	6.7m	3.9m	2.4m	1.5m	0.9m
190W / 7.9A	25.3m	15.8m	10.0m	6.0m	3.9m	2.4m	1.5m	0.9m
200W / 8.3A	24.0m	14.9m	9.4m	5.7m	3.6m	2.1m	1.2m	0.9m
210W / 8.8A	22.8m	14.3m	8.8m	5.4m	3.3m	2.1m	1.2m	0.6m
220W / 9.2A	21.9m	13.7m	8.5m	5.4m	3.3m	2.1m	1.2m	0.6m
230W / 9.6A	21.0m	13.1m	8.2m	5.1m	3.0m	1.8m	1.2m	0.6m
240W / 10.0A	20.1m	12.5m	7.9m	4.8m	3.0m	1.8m	1.2m	0.6m
250W / 10.4A	19.2m	12.1m	7.6m	4.5m	2.7m	1.8m	0.9m	0.6m