

LEDLINE OPTIC 1617S WHT

Outdoor · Side Bending

Features

- Symmetric optics, 36° beam angle for wall washing
- IP68 rated, ideal for outdoor uses, not for underwater project
- 5 years warranty

Applications

Front desk, hallways, offices, displays, facades, lobbies, etc.

Bending Directions & Diameters

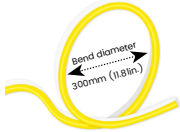

Dimensions

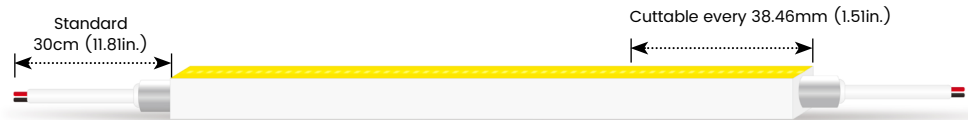
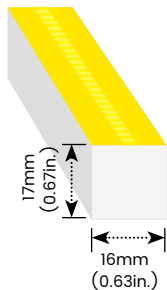

Order Code

Assembly Builder

Model	Bend Direction	Voltage	CCT	Power	Left Feed Entry			
OPTIC1617	S-Side bending	24V-DC24V	927-RA90 2700K	180-18W/M	F	Front	OW	Open wire 30cm(0.98ft)
			930-RA90 3000K		B	Bottom	MC	Male connector with 30cm(0.98ft) cable
			940-RA90 4000K		S	Side	FC	Female connector with 30cm(0.98ft) cable
					C	Closed	NA	Only for Closed Feed Entry

Assembly Builder

Mounting Order Code

Right Feed Entry				Length	
F	Front	OW	Open wire 30cm(0.98ft)	Max. nominal	5m (16.4ft)
B	Bottom	MC	Male connector with 30cm(0.98ft) cable	Increment	38.46mm (1.5in.)
S	Side	FC	Female connector with 30cm(0.98ft) cable		
C	Closed	NA	Only for Closed Feed Entry		

Product Code

Please select on the Mounting Options page

*We will list the nearest actual manufacturing length on the quotation, based on your requested length.

LEDLINE OPTIC 1617S WHT

Outdoor · Side Bending

Lumen Output (lm/m)

CCT	Side Bending
	18W/M
■ 2700K	1493
■ 3000K	1588
■ 4000K	1691
Max. Run Length	5m

Technical Details

Parameter	Side Bending
Efficacy	88.2lm/W @3000K 18W
CRI	Ra>90
Beam Angle	36° (±8)
LED MacAdam	3 steps
IK Rating	IK09 (With aluminium profile)
Average Life (L80B10)	>40,000 hours
Storage Temperature	-40°C- 65°C
Operating Temperature	-40°C- 65°C

Photometry

OPTIC1617S-24-930-180
LEDLINE OPTIC 1617S, Side bend, 24V, RA90, 3000K, 18W/M

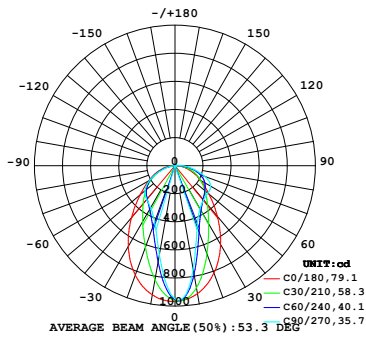

Zone	Lumen	% Fixture
0-30	508.8	32%
0-40	757.6	47.7%
0-60	1229	77.4%
0-90	1568	98.8%
0-180	1588	100%

LEDLINE OPTIC 1617S WHT

Outdoor · Side Bending

Feed Entry / End Cap Options

FT: Flush Translucent – IP68, factory-made only

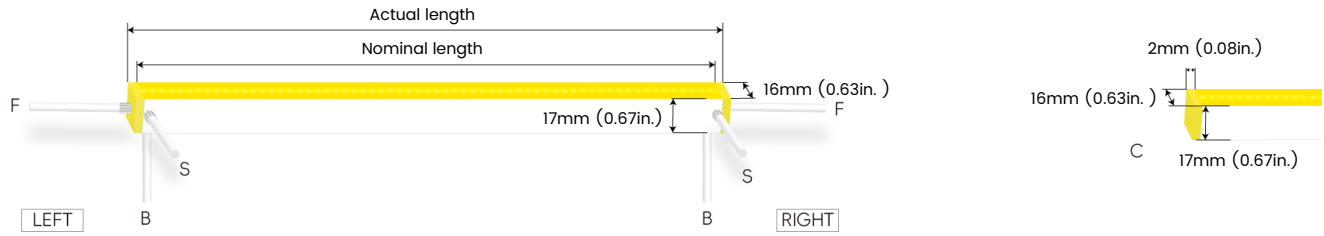

Silicone end cap – IP67, for field cuttable only

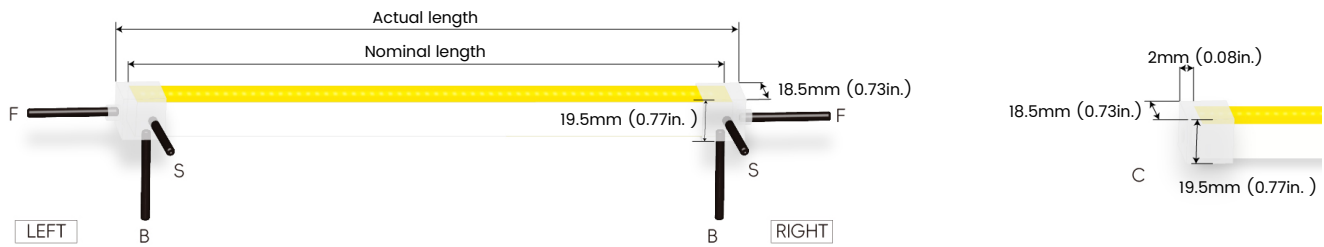

Connector Wire Options



OW: Open wire, **Dry only**
Standard 30cm (0.98ft), 18 AWG,
wire length customizable

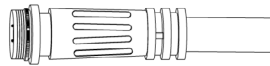

MC: Male connector, **Wet**
Standard 30cm (0.98ft), 18 AWG



FC: Female connector, **Wet**
Standard 30cm (0.98ft), 18 AWG

LEDLINE OPTIC 1617S WHT

Outdoor · Side Bending

Mounting Options

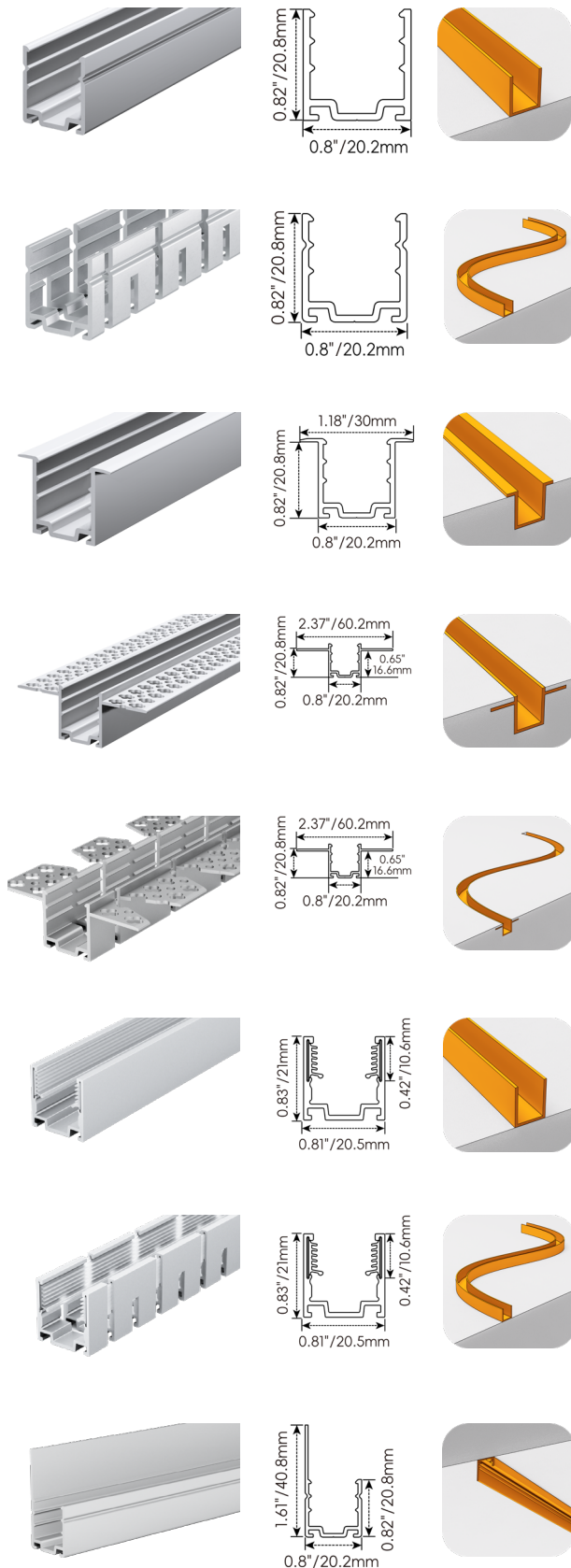

AC167-AP

Name	Straight surface profile
Material	Aluminum
Standard Length	1M (3.28ft)

AC167-CR

Name	Bendable surface profile
Material	Aluminum
Standard Length	1M (3.28ft)
Min. Bending Diameter	600mm (23.6in.)

AC167-EP

Name	Straight recessed profile
Material	Aluminum
Standard Length	1M (3.28ft)

AC167-LP

Name	Mud-in profile
Material	Aluminum
Standard Length	1M (3.28ft)

AC167-SCRL

Name	Bendable mud-in profile
Material	Aluminum
Standard Length	1M (3.28ft)
Min. Bending Diameter	600mm (23.6in.)

AC167-SGP

Name	Straight surface profile
Material	Aluminum with silicone groove
Standard Length	1M (3.28ft)

AC167-CSGP

Name	Bendable surface profile
Material	Aluminum with silicone groove
Standard Length	1M (3.28ft)
Min. Bending Diameter	600mm (23.6in.) only side bend

AC167-BA

Name	Light-block profile
Material	Aluminum
Standard Length	1M (3.28ft)

LEDLINE OPTIC 1617S WHT

Outdoor · Side Bending

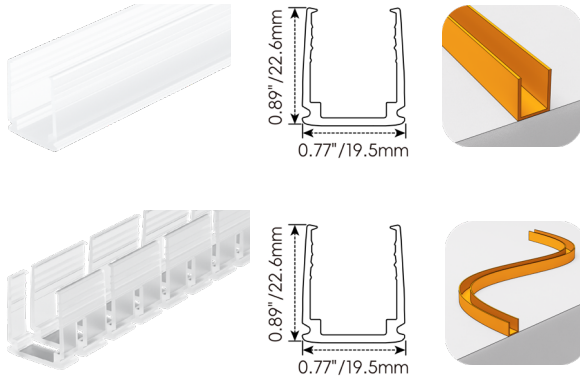

AC167-PC	
Name	PC profile
Material	Polycarbonate
Standard Length	1M (3.28ft)

AC167-CPC	
Name	Bendable PC profile
Material	Polycarbonate
Standard Length	1M (3.28ft)
Min. Bending Diameter	300mm (11.8in.)

Clip Options

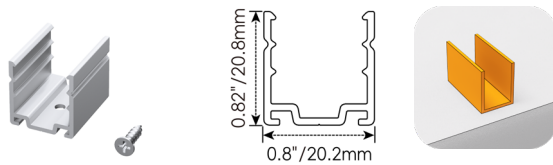

AC167-MC	
Name	Mounting clip
Material	Aluminum
Standard Length	25mm (0.98in.)

Bracket Options

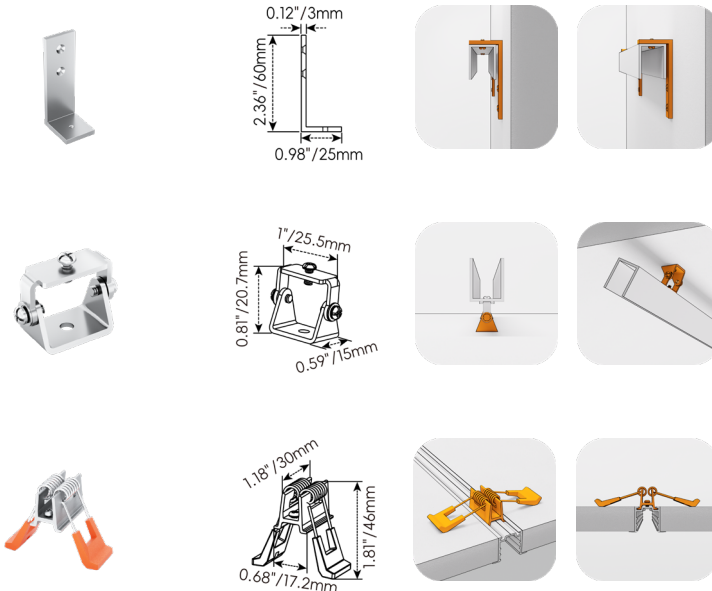

AC167-SET-LA	
Name	L-shaped mounting bracket
Material	Aluminum
Standard Length	20mm (0.79in.)
* AC167-SET-LA must be installed with AC167-AP	

AC167-AMB	
Name	Adjustable mounting clip
Material	Stainless steel
Standard Length	25.5mm (1 in.)
* AC167-AMB must be installed with AC167-AP	

AC167-SET-LC	
Name	Spring clip
Standard Pkg	1pcs
* AC167-SET-LC must be installed with AC167-EP	

Tool Options

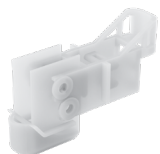

IF-167	
Name	Fixture
Material	Resin
Standard Pkg	1pcs
* Insertion Fixture for AC167-CPC	

LEDLINE OPTIC 1617S WHT

Silicone End Caps (Optional, purchase for extra)

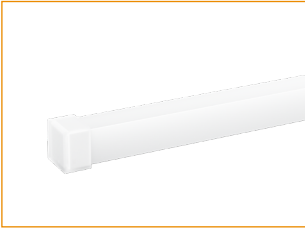

AC167-EC
Silicone closed end cap

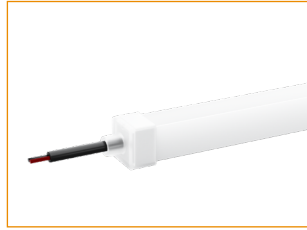

AC167-EC2-F
Silicone end cap front entry with
30cm (0.98ft) cable, 2 pin

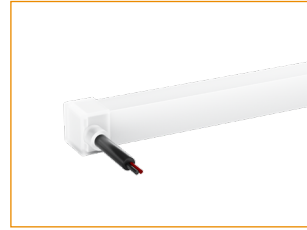

AC167-EC2-S
Silicone end cap side entry with
30cm (0.98ft) cable, 2 pin



AC167-EC2-B
Silicone end cap bottom entry with
30cm (0.98ft) cable, 2 pin

Additional Accessories (Optional, purchase for extra)



AD007-2-MCW
Male connector,
30cm (0.98ft) UL white cable,
2 pin, IP67, Wet, 18 AWG



AD007-2-FCW
Female connector,
30cm (0.98ft) UL white cable,
2 pin, IP67, Wet, 18 AWG



AD007-2-MCB
Male connector,
30cm (0.98ft) black cable,
2 pin, IP67, Wet, 18 AWG



AD007-2-FCB
Female connector,
30cm (0.98ft) black cable,
2 pin, IP67, Wet, 18 AWG



AF001-1
1 Adjustable angle scissors set,
with 4 spare blades

LEDLINE OPTIC 1617S WHT

Outdoor · Side Bending

Drivers

Non-dimmable

Code	Max Load	Input	Output	Environment	Size (L x W x H)
ELG-150-24A-3Y	150W	100-305VAC	24V	Dry/Damp/IP67	219 * 63 * 35.5 mm
LRS-150-24	150W	85-132VAC / 170-264VAC	24V	Dry	159 * 97 * 30 mm

3 in 1-dimmable

Code	Max Load	Input	Output	Environment	Size (L x W x H)
ELG-150-24B-3Y	150W	100-305VAC	24V	Dry/Damp/IP67	219 * 63 * 35.5 mm

DALI-dimmable

Code	Max Load	Input	Output	Environment	Size (L x W x H)
ELG-150-24DA-3Y	150W	100-305VAC	24V	Dry/Damp/IP67	219 * 63 * 35.5 mm

Wiring Diagram

Non-dimmable

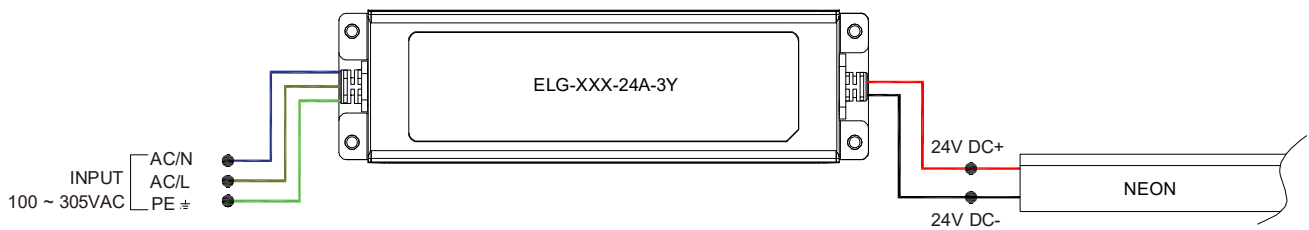

3 in 1-dimmable

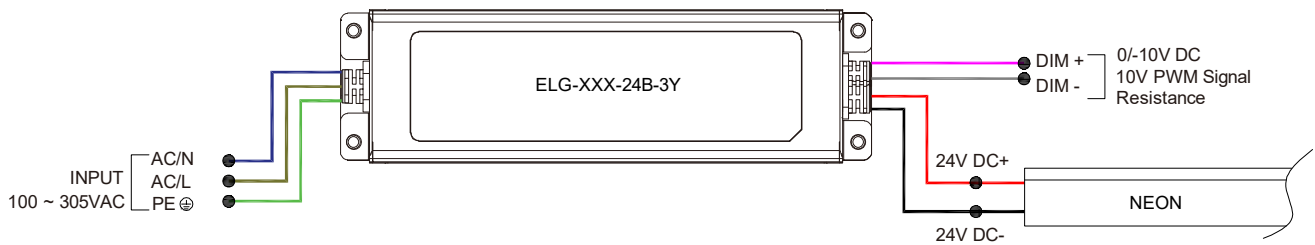

DALI-dimmable

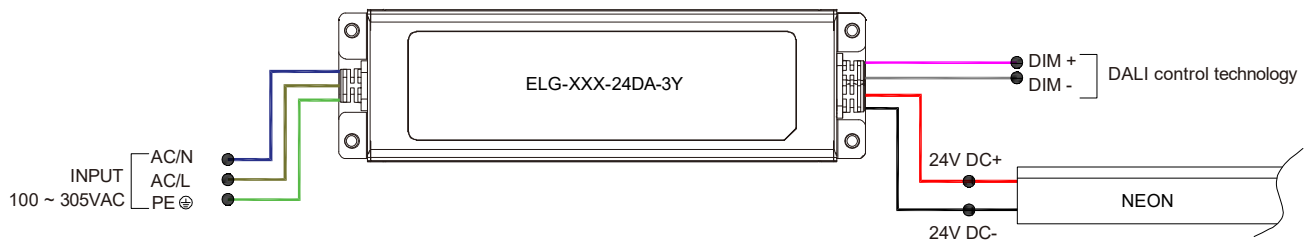

LEDLINE OPTIC 1617S WHT

Outdoor · Side Bending

24V Voltage Drop & Maximum Wire Length Chart

Based on 24V voltage with a 3% voltage drop allowance. Indicates the maximum wire length from the power supply to the start of the run.

Total load	8AWG	10AWG	12AWG	14AWG	16AWG	18AWG	20AWG	22AWG
10W / 0.4A	484.0m	304.5m	191.4m	120.4m	75.5m	47.5m	29.8m	18.5m
20W / 0.8A	242.0m	152.1m	95.7m	60.0m	37.8m	23.7m	14.9m	9.1m
30W / 1.3A	161.2m	101.5m	63.7m	39.9m	24.9m	15.8m	9.7m	6.1m
40W / 1.7A	121.0m	75.9m	47.8m	29.8m	18.9m	11.8m	7.3m	4.5m
50W / 2.1A	96.6m	60.6m	38.1m	24.0m	14.9m	9.4m	5.7m	3.6m
60W / 2.5A	80.4m	50.6m	31.7m	19.8m	12.5m	7.9m	4.8m	3.0m
70W / 2.9A	68.8m	43.2m	27.1m	17.0m	10.6m	6.7m	4.2m	2.4m
80W / 3.3A	60.3m	37.8m	23.7m	14.9m	9.4m	5.7m	3.6m	2.1m
90W / 3.8A	53.6m	33.8m	21.0m	13.1m	8.2m	5.1m	3.0m	1.8m
100W / 4.2A	48.1m	30.1m	18.9m	11.8m	7.3m	4.5m	2.7m	1.8m
110W / 4.6A	43.8m	27.4m	17.3m	10.6m	6.7m	4.2m	2.7m	1.5m
120W / 5.0A	40.2m	25.3m	15.8m	9.7m	6.1m	3.9m	2.4m	1.5m
130W / 5.4A	37.1m	23.1m	14.6m	9.1m	5.7m	3.6m	2.1m	1.2m
140W / 5.8A	34.4m	21.6m	13.4m	8.5m	5.1m	3.3m	2.1m	1.2m
150W / 6.3A	32.0m	20.1m	12.5m	7.9m	4.8m	3.0m	1.8m	1.2m
160W / 6.7A	30.1m	18.9m	11.8m	7.3m	4.5m	2.7m	1.8m	0.9m
170W / 7.1A	28.3m	17.6m	10.9m	7.0m	4.2m	2.7m	1.5m	0.9m
180W / 7.5A	26.8m	16.7m	10.3m	6.7m	3.9m	2.4m	1.5m	0.9m
190W / 7.9A	25.3m	15.8m	10.0m	6.0m	3.9m	2.4m	1.5m	0.9m
200W / 8.3A	24.0m	14.9m	9.4m	5.7m	3.6m	2.1m	1.2m	0.9m
210W / 8.8A	22.8m	14.3m	8.8m	5.4m	3.3m	2.1m	1.2m	0.6m
220W / 9.2A	21.9m	13.7m	8.5m	5.4m	3.3m	2.1m	1.2m	0.6m
230W / 9.6A	21.0m	13.1m	8.2m	5.1m	3.0m	1.8m	1.2m	0.6m
240W / 10.0A	20.1m	12.5m	7.9m	4.8m	3.0m	1.8m	1.2m	0.6m
250W / 10.4A	19.2m	12.1m	7.6m	4.5m	2.7m	1.8m	0.9m	0.6m