

Features

- Smooth surface with cutting mark without seeing PCB and support reminding wrong bending
- IP68 protection (not for underwater application), UV resistance, and chemical resistance ensure the durability in various environments.
- Equipped with DMX control mode and dot-free lighting technology guarantees gorgeous color changing & fading lighting performance over its rated lifetime
- 3 years warranty

Applications

Living rooms, TV walls, feature walls, under-cabinet areas, staircases, ceiling coves, hallways, etc.

Date	Fixture type
Project name	Project phase

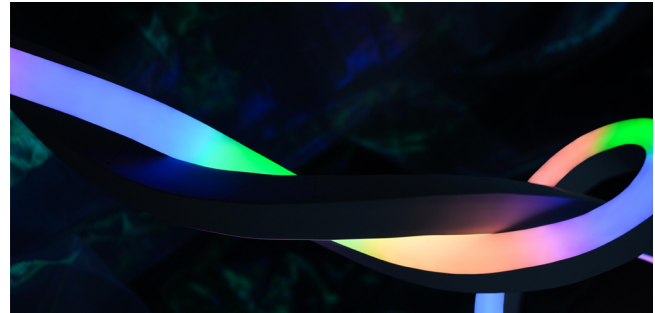

Bending Directions & Diameters

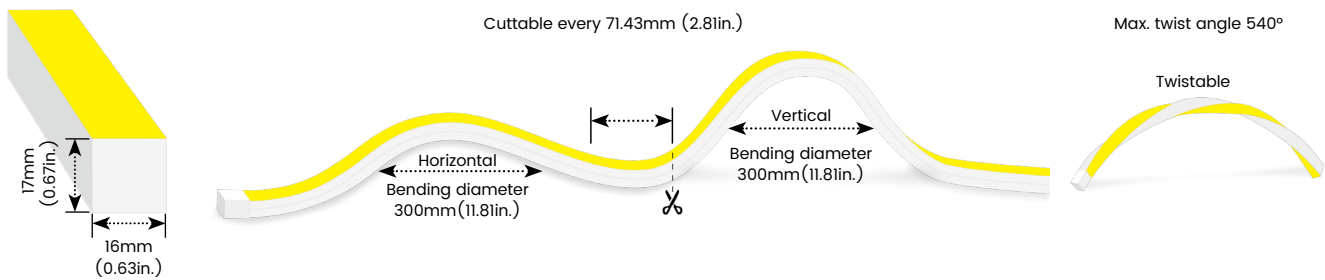

Order Code

Assembly Builder

Model	Bend Direction	Voltage	Control	CCT	Power	Left Feed Entry	
AXE1617	3D-3D bending	24V-DC24V	DMX-DMX control	RGBW827-RGBW(RA80 2700K) RGBW830-RGBW(RA80 3000K)	150-15W/M	F Front	OW Open wire 30cm(0.98ft)
						B Bottom	MC Male connector with 30cm(0.98ft) cable
						S Side	FC Female connector with 30cm(0.98ft)cable
						C Closed	NA Only for Closed Feed Entry

Assembly Builder

Mounting Order Code

Right Feed Entry			Length	
F	Front	OW Open wire 30cm(0.98ft)	Max. nominal	8m(26.25ft)
B	Bottom	MC Male connector with 30cm(0.98ft) cable	Increment	71.43mm (2.8in.)
S	Side	FC Female connector with 30cm(0.98ft)cable		
C	Closed	NA Only for Closed Feed Entry		

Product Code
Please select on the Mounting Options page

*We will list the nearest actual manufacturing length on the quotation, based on your requested length.

LEDLINE AXE 1617 DMX RGBW

3D Bending · Pixel RGBW

Lumen Output (lm/m)

CCT	15W/M
R	29
G	105
B	24
W27K	77
W30K	83
RGBW27K	236
RGBW30K	240
Max. Run Length	8m

Technical Details

Efficacy	16lm/W @RGBW30K 15W
CRI	Ra>80
Beam Angle	110°
IK Rating	IK10 (with aluminium profile)
Average Life (L70B10)	>32,000 hours
IC Model	UCS 512CLN
Pixels/M	14
Storage Temperature	-40°C- 65°C
Operating Temperature	-40°C- 65°C

Photometry

AXE16173D-24-DMX-RGBW830-150

LEDLINE AXE 1617, 3D bending, 24V, DMX control, RGBW(RA80, 3000K), 15W/M

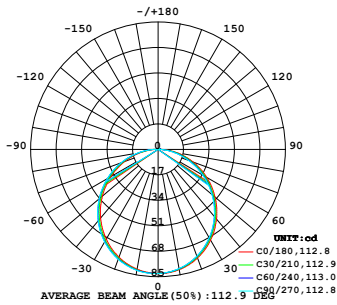

Zonal Lumen Summary

Zone	Lumen	% Fixture
0-30	64.16	26.2%
0-40	105.0	42.9%
0-60	185.9	76.76%
0-90	241.9	98.9%
0-180	244.6	100.0%

Feed Entry / End Cap Options

FT: Flush Translucent – IP68, factory-made only

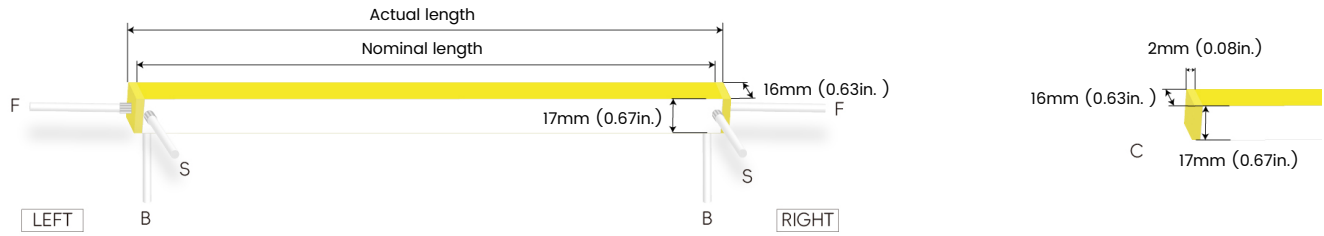

Silicone end cap – IP67, for field cuttable only

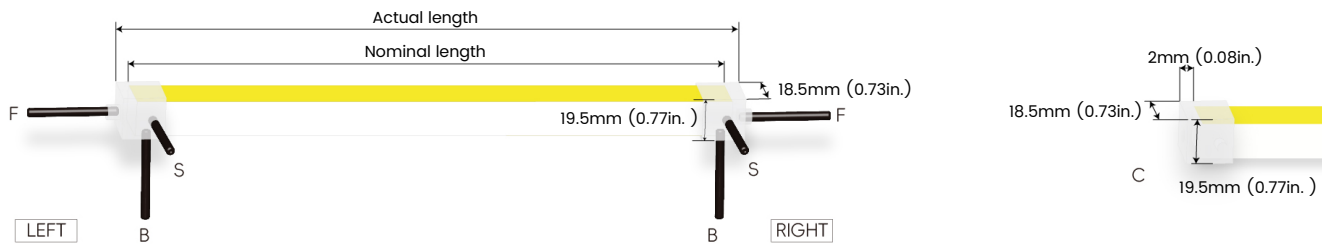

Connector Wire Options



OW: Open wire, **Dry only**
Standard 30cm (0.98ft), 20 AWG,
wire length customizable

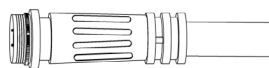



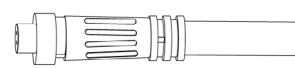





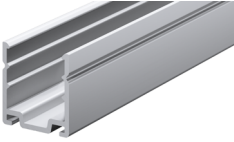
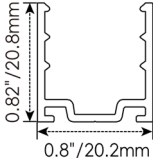

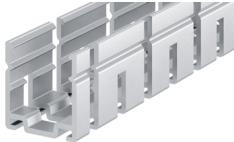
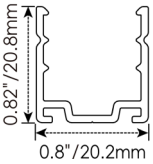
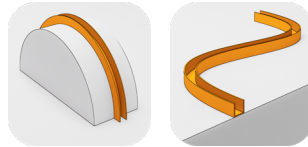
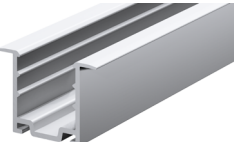
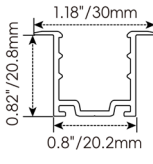

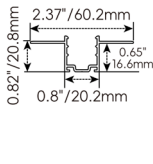
MC: Male connector, **Wet**
Standard 30cm (0.98ft), 20 AWG

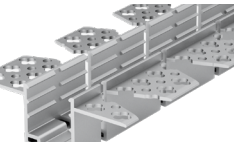
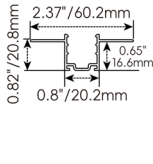
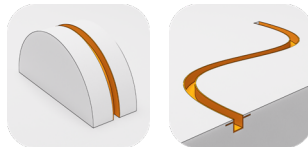

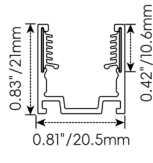
FC: Female connector, **Wet**
Standard 30cm (0.98ft), 20 AWG

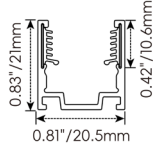
Mounting Options

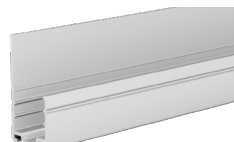
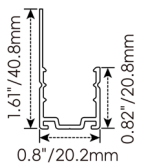
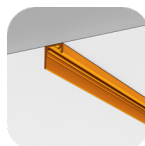
			<p>AC167-AP</p> <table border="1"> <tr> <td>Name</td> <td>Straight surface profile</td> </tr> <tr> <td>Material</td> <td>Aluminum</td> </tr> <tr> <td>Standard Length</td> <td>1M (3.28ft)</td> </tr> </table>	Name	Straight surface profile	Material	Aluminum	Standard Length	1M (3.28ft)		
Name	Straight surface profile										
Material	Aluminum										
Standard Length	1M (3.28ft)										
			<p>AC167-CR</p> <table border="1"> <tr> <td>Name</td> <td>Bendable surface profile</td> </tr> <tr> <td>Material</td> <td>Aluminum</td> </tr> <tr> <td>Standard Length</td> <td>1M (3.28ft)</td> </tr> <tr> <td>Min. Bending Diameter</td> <td>600mm (23.6in.)</td> </tr> </table>	Name	Bendable surface profile	Material	Aluminum	Standard Length	1M (3.28ft)	Min. Bending Diameter	600mm (23.6in.)
Name	Bendable surface profile										
Material	Aluminum										
Standard Length	1M (3.28ft)										
Min. Bending Diameter	600mm (23.6in.)										
			<p>AC167-EP</p> <table border="1"> <tr> <td>Name</td> <td>Straight recessed profile</td> </tr> <tr> <td>Material</td> <td>Aluminum</td> </tr> <tr> <td>Standard Length</td> <td>1M (3.28ft)</td> </tr> </table>	Name	Straight recessed profile	Material	Aluminum	Standard Length	1M (3.28ft)		
Name	Straight recessed profile										
Material	Aluminum										
Standard Length	1M (3.28ft)										
			<p>AC167-LP</p> <table border="1"> <tr> <td>Name</td> <td>Mud-in profile</td> </tr> <tr> <td>Material</td> <td>Aluminum</td> </tr> <tr> <td>Standard Length</td> <td>1M (3.28ft)</td> </tr> </table>	Name	Mud-in profile	Material	Aluminum	Standard Length	1M (3.28ft)		
Name	Mud-in profile										
Material	Aluminum										
Standard Length	1M (3.28ft)										
			<p>AC167-SCRL</p> <table border="1"> <tr> <td>Name</td> <td>Bendable mud-in profile</td> </tr> <tr> <td>Material</td> <td>Aluminum</td> </tr> <tr> <td>Standard Length</td> <td>1M (3.28ft)</td> </tr> <tr> <td>Min. Bending Diameter</td> <td>600mm (23.6in.)</td> </tr> </table>	Name	Bendable mud-in profile	Material	Aluminum	Standard Length	1M (3.28ft)	Min. Bending Diameter	600mm (23.6in.)
Name	Bendable mud-in profile										
Material	Aluminum										
Standard Length	1M (3.28ft)										
Min. Bending Diameter	600mm (23.6in.)										
			<p>AC167-SGP</p> <table border="1"> <tr> <td>Name</td> <td>Straight surface profile</td> </tr> <tr> <td>Material</td> <td>Aluminum with silicone groove</td> </tr> <tr> <td>Standard Length</td> <td>1M (3.28ft)</td> </tr> </table>	Name	Straight surface profile	Material	Aluminum with silicone groove	Standard Length	1M (3.28ft)		
Name	Straight surface profile										
Material	Aluminum with silicone groove										
Standard Length	1M (3.28ft)										
			<p>AC167-CSGP</p> <table border="1"> <tr> <td>Name</td> <td>Bendable surface profile</td> </tr> <tr> <td>Material</td> <td>Aluminum with silicone groove</td> </tr> <tr> <td>Standard Length</td> <td>1M (3.28ft)</td> </tr> <tr> <td>Min. Bending Diameter</td> <td>600mm (23.6in.) only side bend</td> </tr> </table>	Name	Bendable surface profile	Material	Aluminum with silicone groove	Standard Length	1M (3.28ft)	Min. Bending Diameter	600mm (23.6in.) only side bend
Name	Bendable surface profile										
Material	Aluminum with silicone groove										
Standard Length	1M (3.28ft)										
Min. Bending Diameter	600mm (23.6in.) only side bend										
			<p>AC167-BA</p> <table border="1"> <tr> <td>Name</td> <td>Light-block profile</td> </tr> <tr> <td>Material</td> <td>Aluminum</td> </tr> <tr> <td>Standard Length</td> <td>1M (3.28ft)</td> </tr> </table>	Name	Light-block profile	Material	Aluminum	Standard Length	1M (3.28ft)		
Name	Light-block profile										
Material	Aluminum										
Standard Length	1M (3.28ft)										

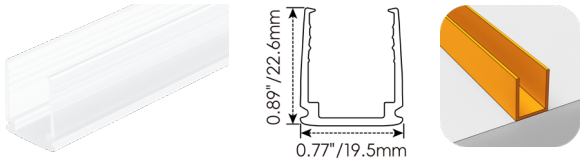

AC167-PC	
Name	PC profile
Material	Polycarbonate
Standard Length	1M (3.28ft)

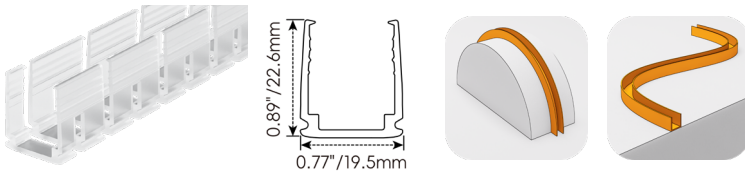

AC167-CPC	
Name	Bendable PC profile
Material	Polycarbonate
Standard Length	1M (3.28ft)
Min. Bending Diameter	300mm (11.8in.)

Clip Options

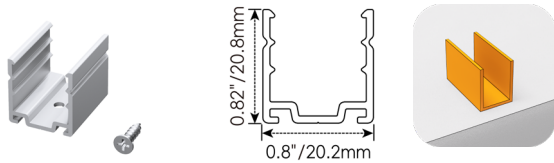

AC167-MC	
Name	Mounting clip
Material	Aluminum
Standard Length	25mm (0.98in.)

Bracket Options

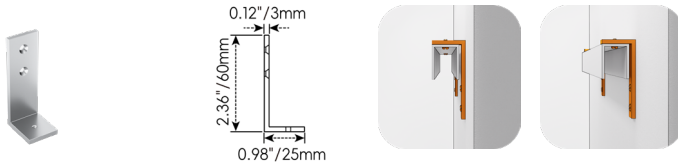

AC167-SET-LA	
Name	L-shaped mounting bracket
Material	Aluminum
Standard Length	20mm (0.79in.)
* AC167-SET-LA must be installed with AC167-AP	

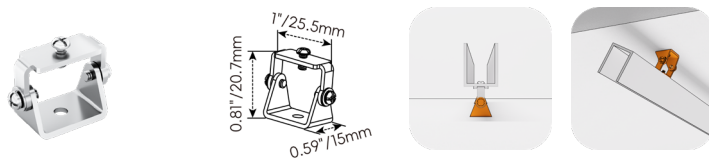

AC167-AMB	
Name	Adjustable mounting clip
Material	Stainless steel
Standard Length	25.5mm (1 in.)
* AC167-AMB must be installed with AC167-AP	

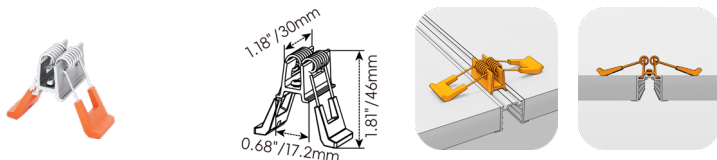

AC167-SET-LC	
Name	Spring clip
Standard Pkg	1pcs
* AC167-SET-LC must be installed with AC167-EP	

Tool Options

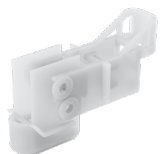

IF-167	
Name	Fixture
Material	Resin
Standard Pkg	1pcs
* Insertion Fixture for AC167-CPC	

Silicone End Caps (Optional, purchase for extra)

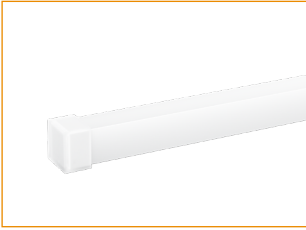

AC167-EC
Silicone closed end cap

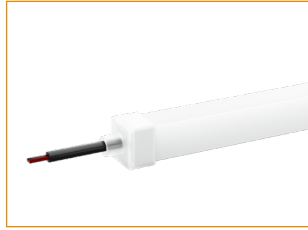

AC167-EC5-F
Silicone end cap front entry with 30cm (0.98ft) cable, 2 pin

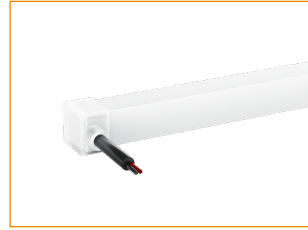

AC167-EC5-S
Silicone end cap side entry with 30cm (0.98ft) cable, 2 pin



AC167-EC5-B
Silicone end cap bottom entry with 30cm (0.98ft) cable, 2 pin

Additional Accessories (Optional, purchase for extra)



AD007-5-MCW
Male connector, 30cm (0.98ft) UL white cable, 5 pin, IP67, Wet, 20 AWG



AD007-5-FCW
Female connector, 30cm (0.98ft) UL white cable, 5 pin, IP67, Wet, 20 AWG



AD007-5-MCB
Male connector, 30cm (0.98ft) black cable, 5 pin, IP67, Wet, 20 AWG



AD007-5-FCB
Female connector, 30cm (0.98ft) black cable, 5 pin, IP67, Wet, 20 AWG



AF001-1
1 Adjustable angle scissors set, with 4 spare blades

Drivers

Non-dimmable

Code	Max Load	Input	Output	Environment	Size (L x W x H)
ELG-150-24A-3Y	150W	100-305VAC	24V	Dry/Damp/IP67	219 * 63 * 35.5 mm
LRS-150-24	150W	85-132VAC / 170-264VAC	24V	Dry	159 * 97 * 30 mm

DMX-Decoders & Controllers Options

Type	Code	Description	Environment	Size (L x W x H)
Controllers	K-1000C	2048 pixels, SD card playback, ideal for DIY, signage and small venues.	Indoor	159 * 89 * 24 mm
Controllers	T-790K	8-port output, dual-mode control, ideal for facades, stages and large projects.	Indoor	310 * 152 * 42 mm
Controllers	WT-DMX-M	WiFi & RF 3-in-1 DMX512 controller for RGB/RGBW/RGBCCT lighting	Indoor	120 * 43 * 27 mm

Wiring Diagram

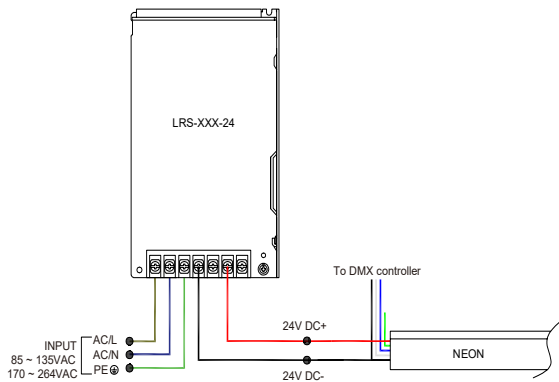
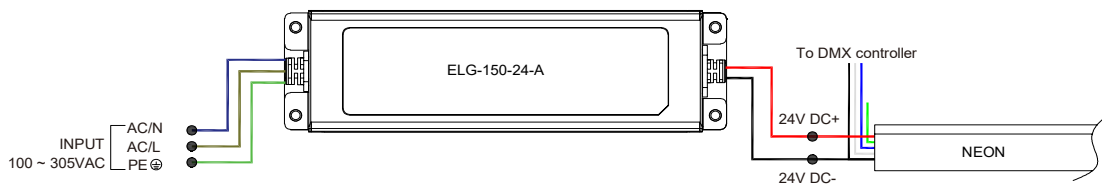

LEDLINE AXE 1617 DMX RGBW

3D Bending · Pixel RGBW

24V Voltage Drop & Maximum Wire Length Chart

Based on 24V voltage with a 3% voltage drop allowance. Indicates the maximum wire length from the power supply to the start of the run.

Total load	8AWG	10AWG	12AWG	14AWG	16AWG	18AWG	20AWG	22AWG
10W / 0.4A	484.0m	304.5m	191.4m	120.4m	75.5m	47.5m	29.8m	18.5m
20W / 0.8A	242.0m	152.1m	95.7m	60.0m	37.8m	23.7m	14.9m	9.1m
30W / 1.3A	161.2m	101.5m	63.7m	39.9m	24.9m	15.8m	9.7m	6.1m
40W / 1.7A	121.0m	75.9m	47.8m	29.8m	18.9m	11.8m	7.3m	4.5m
50W / 2.1A	96.6m	60.6m	38.1m	24.0m	14.9m	9.4m	5.7m	3.6m
60W / 2.5A	80.4m	50.6m	31.7m	19.8m	12.5m	7.9m	4.8m	3.0m
70W / 2.9A	68.8m	43.2m	27.1m	17.0m	10.6m	6.7m	4.2m	2.4m
80W / 3.3A	60.3m	37.8m	23.7m	14.9m	9.4m	5.7m	3.6m	2.1m
90W / 3.8A	53.6m	33.8m	21.0m	13.1m	8.2m	5.1m	3.0m	1.8m
100W / 4.2A	48.1m	30.1m	18.9m	11.8m	7.3m	4.5m	2.7m	1.8m
110W / 4.6A	43.8m	27.4m	17.3m	10.6m	6.7m	4.2m	2.7m	1.5m
120W / 5.0A	40.2m	25.3m	15.8m	9.7m	6.1m	3.9m	2.4m	1.5m
130W / 5.4A	37.1m	23.1m	14.6m	9.1m	5.7m	3.6m	2.1m	1.2m
140W / 5.8A	34.4m	21.6m	13.4m	8.5m	5.1m	3.3m	2.1m	1.2m
150W / 6.3A	32.0m	20.1m	12.5m	7.9m	4.8m	3.0m	1.8m	1.2m
160W / 6.7A	30.1m	18.9m	11.8m	7.3m	4.5m	2.7m	1.8m	0.9m
170W / 7.1A	28.3m	17.6m	10.9m	7.0m	4.2m	2.7m	1.5m	0.9m
180W / 7.5A	26.8m	16.7m	10.3m	6.7m	3.9m	2.4m	1.5m	0.9m
190W / 7.9A	25.3m	15.8m	10.0m	6.0m	3.9m	2.4m	1.5m	0.9m
200W / 8.3A	24.0m	14.9m	9.4m	5.7m	3.6m	2.1m	1.2m	0.9m
210W / 8.8A	22.8m	14.3m	8.8m	5.4m	3.3m	2.1m	1.2m	0.6m
220W / 9.2A	21.9m	13.7m	8.5m	5.4m	3.3m	2.1m	1.2m	0.6m
230W / 9.6A	21.0m	13.1m	8.2m	5.1m	3.0m	1.8m	1.2m	0.6m
240W / 10.0A	20.1m	12.5m	7.9m	4.8m	3.0m	1.8m	1.2m	0.6m
250W / 10.4A	19.2m	12.1m	7.6m	4.5m	2.7m	1.8m	0.9m	0.6m